

FIG. 1

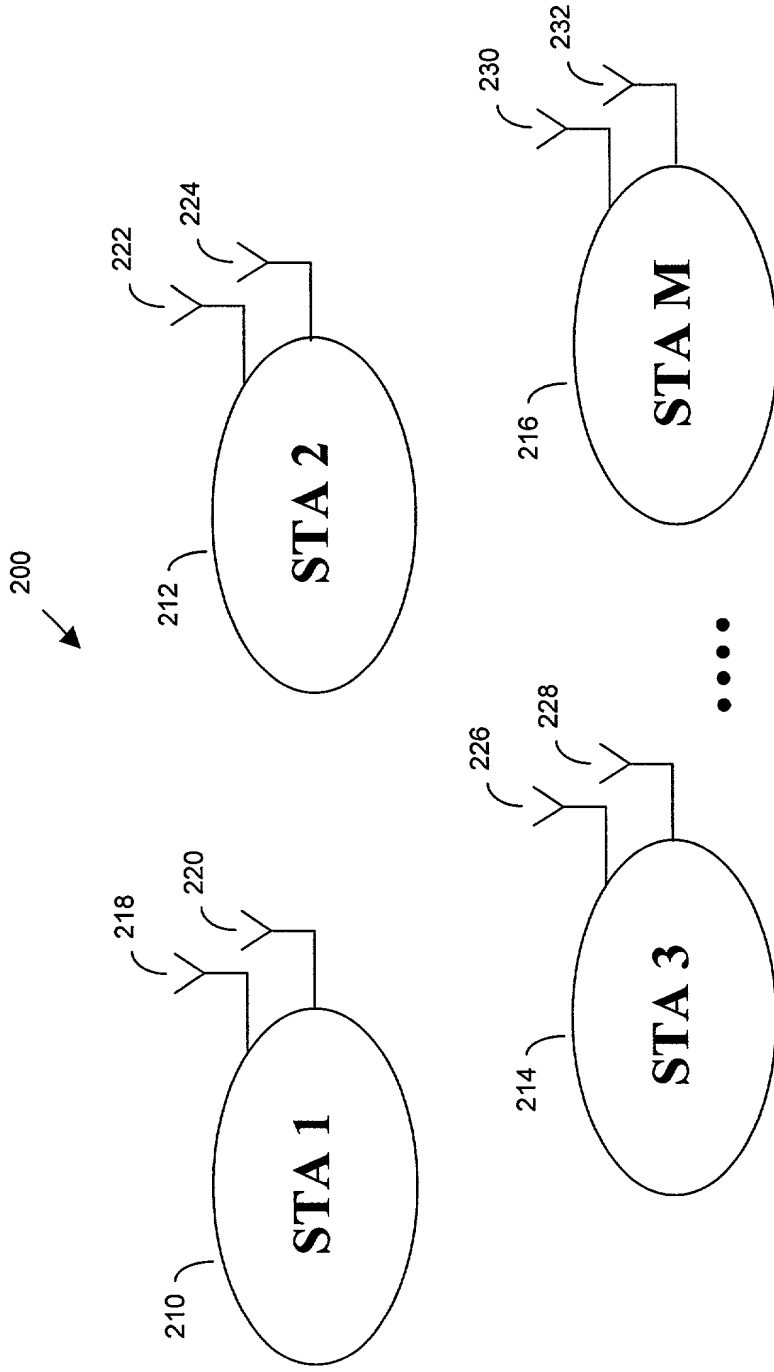

FIG. 2

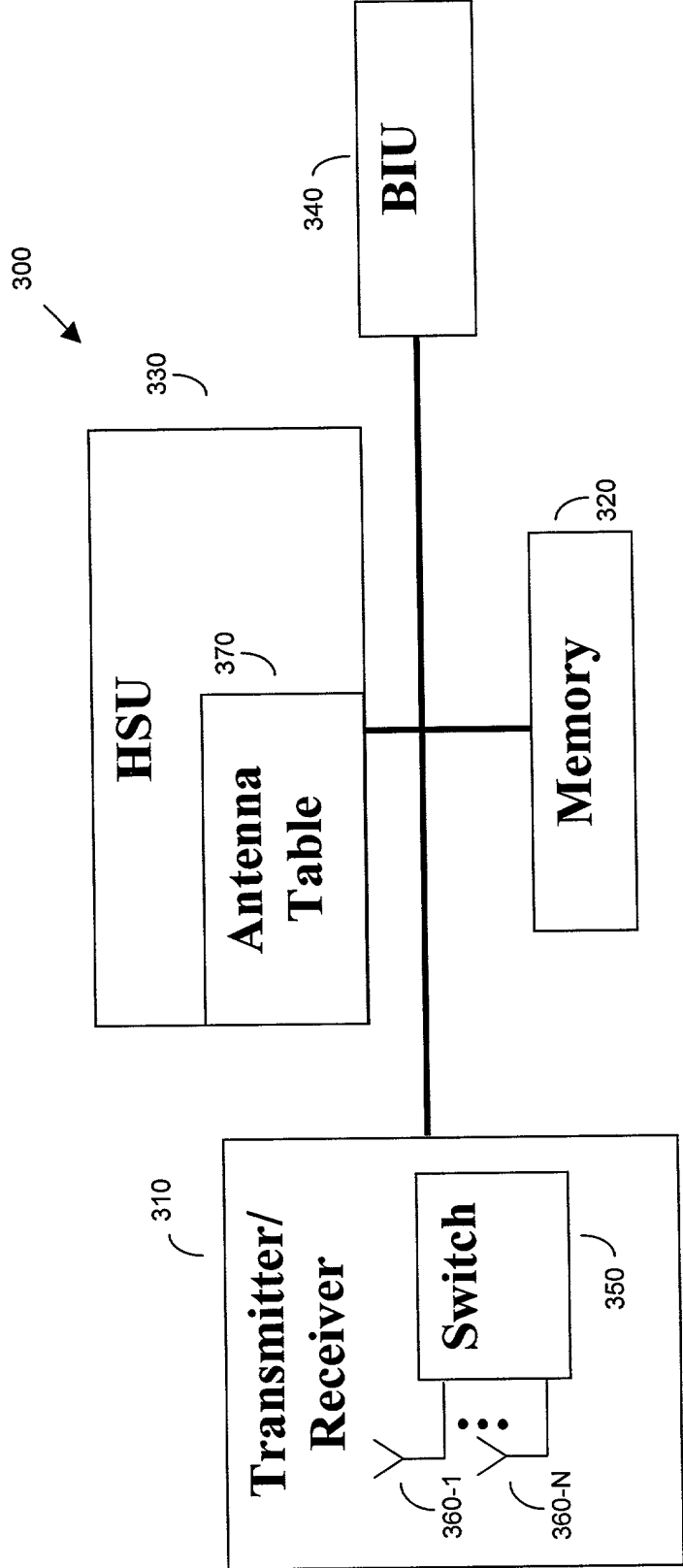

FIG. 3

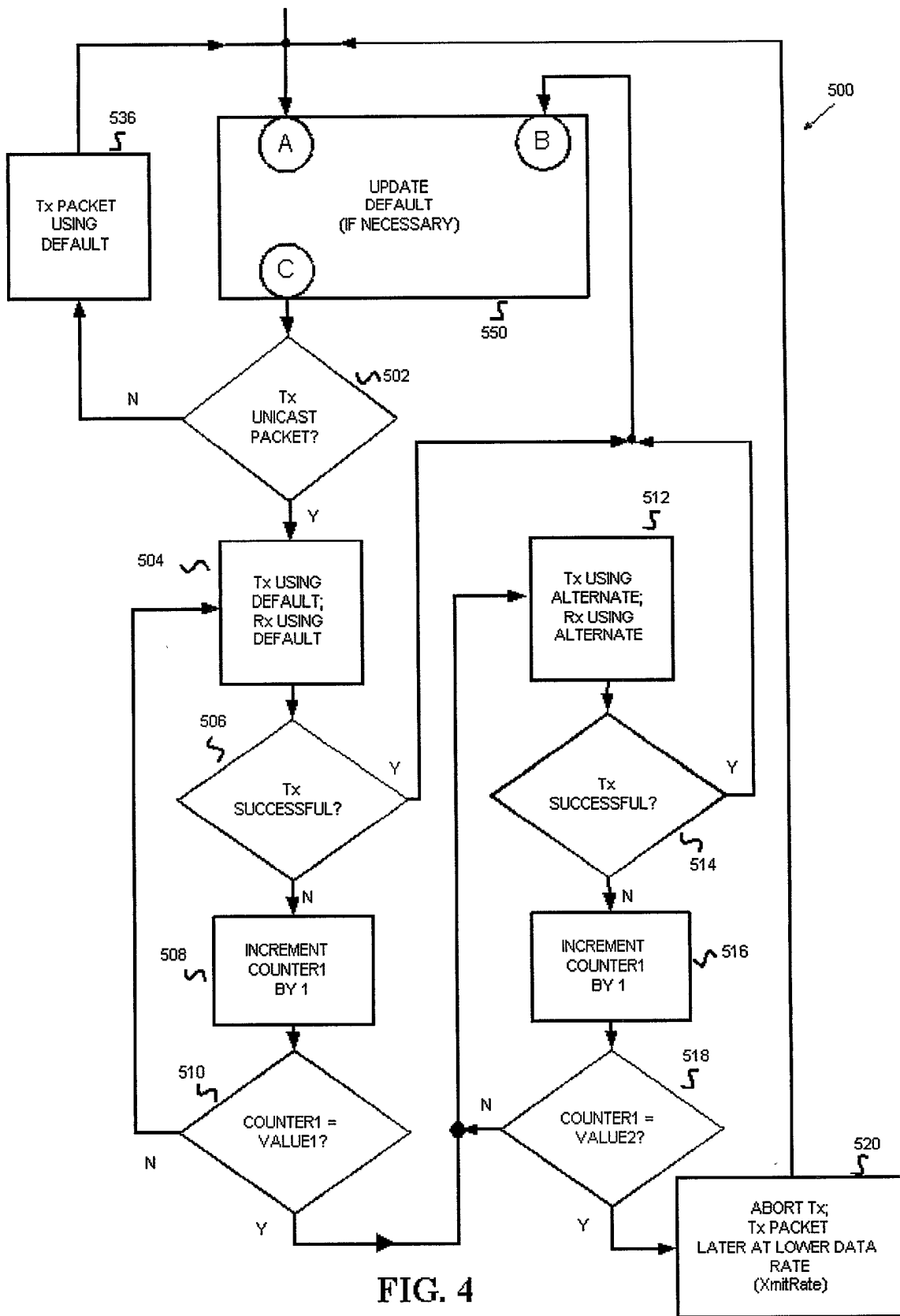

FIG. 4

FOIA b 7 - Exempt

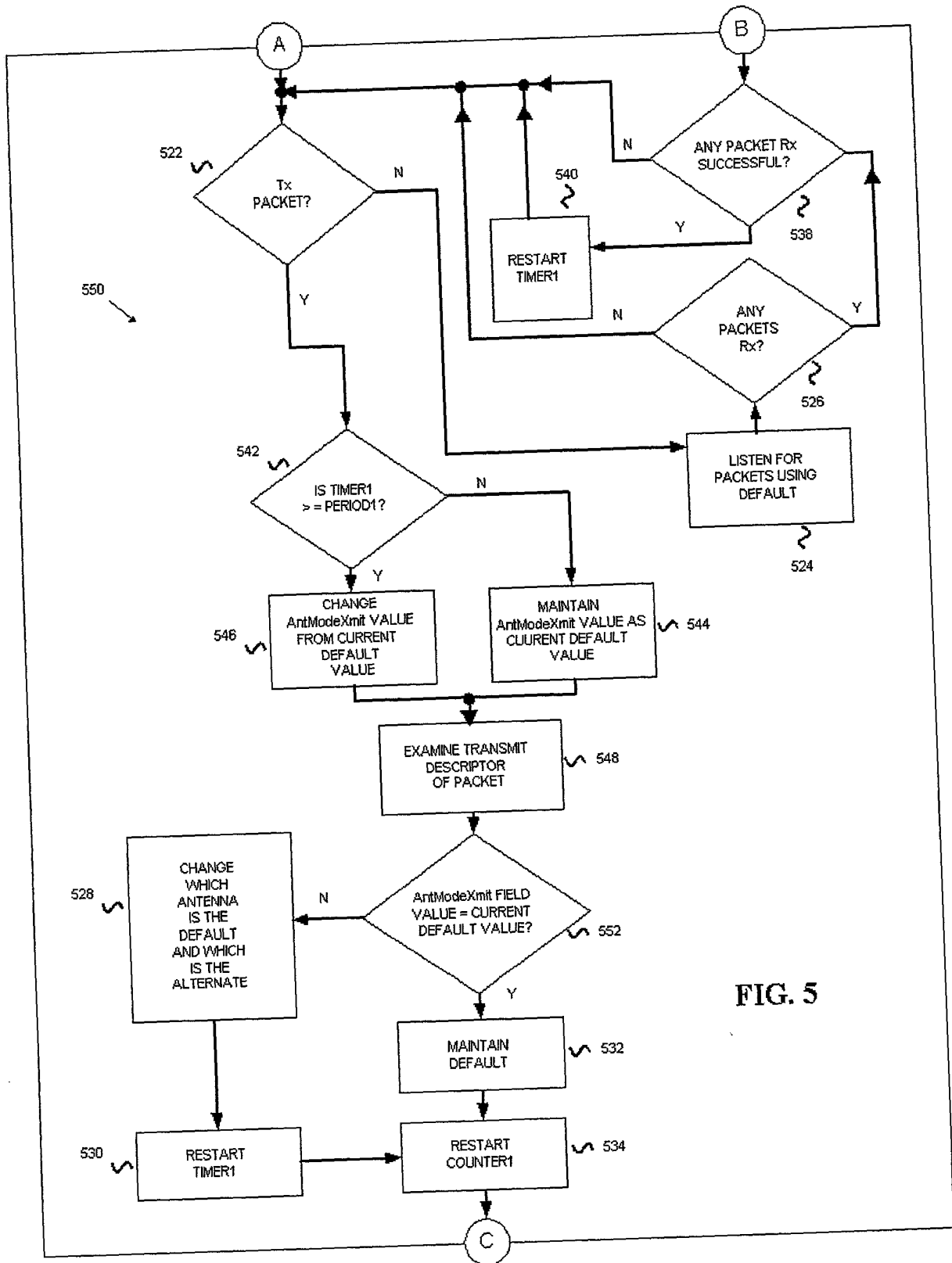

FIG. 5

T06040" 62022550

600

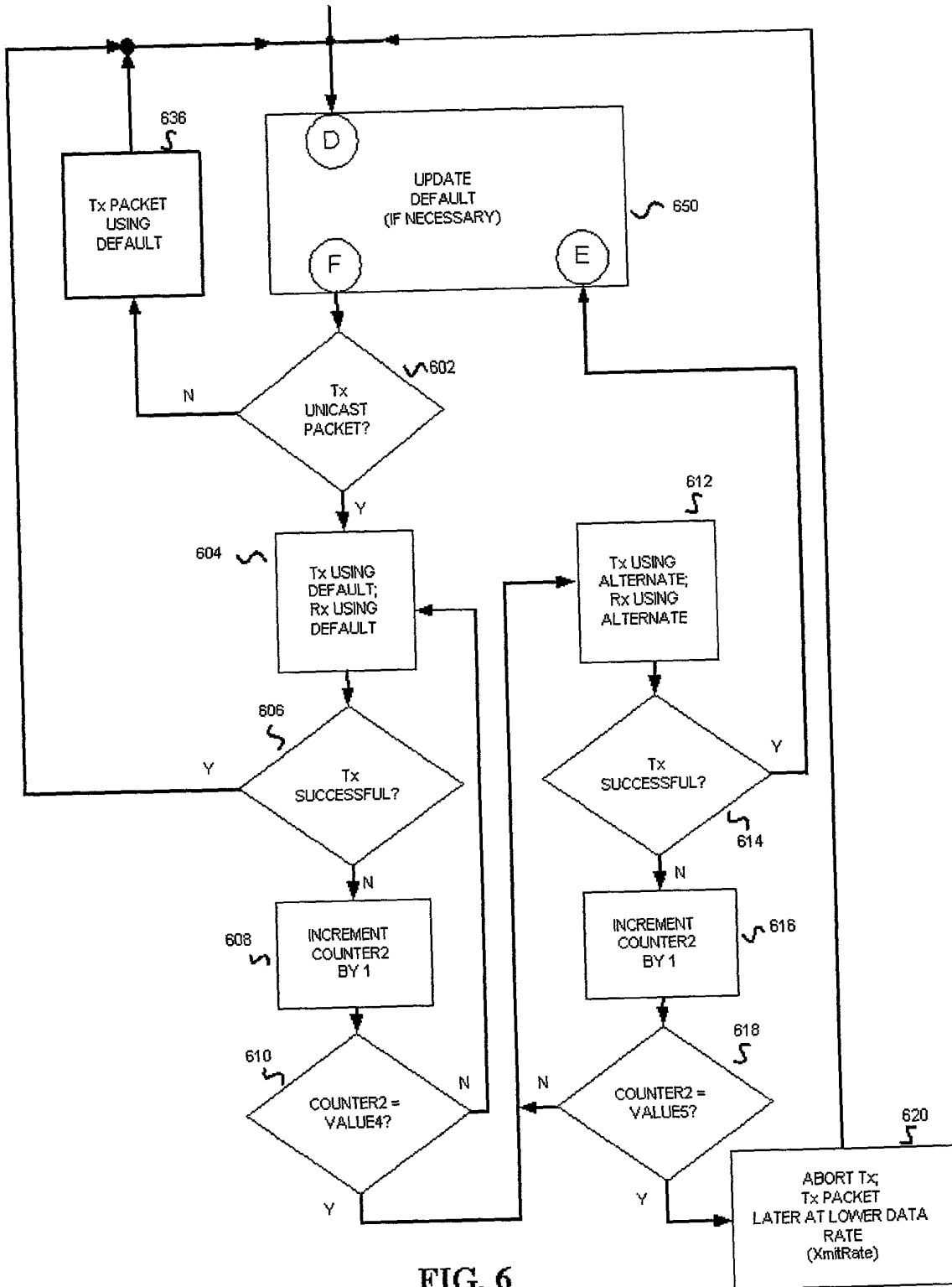

FIG. 6

FIG. 6

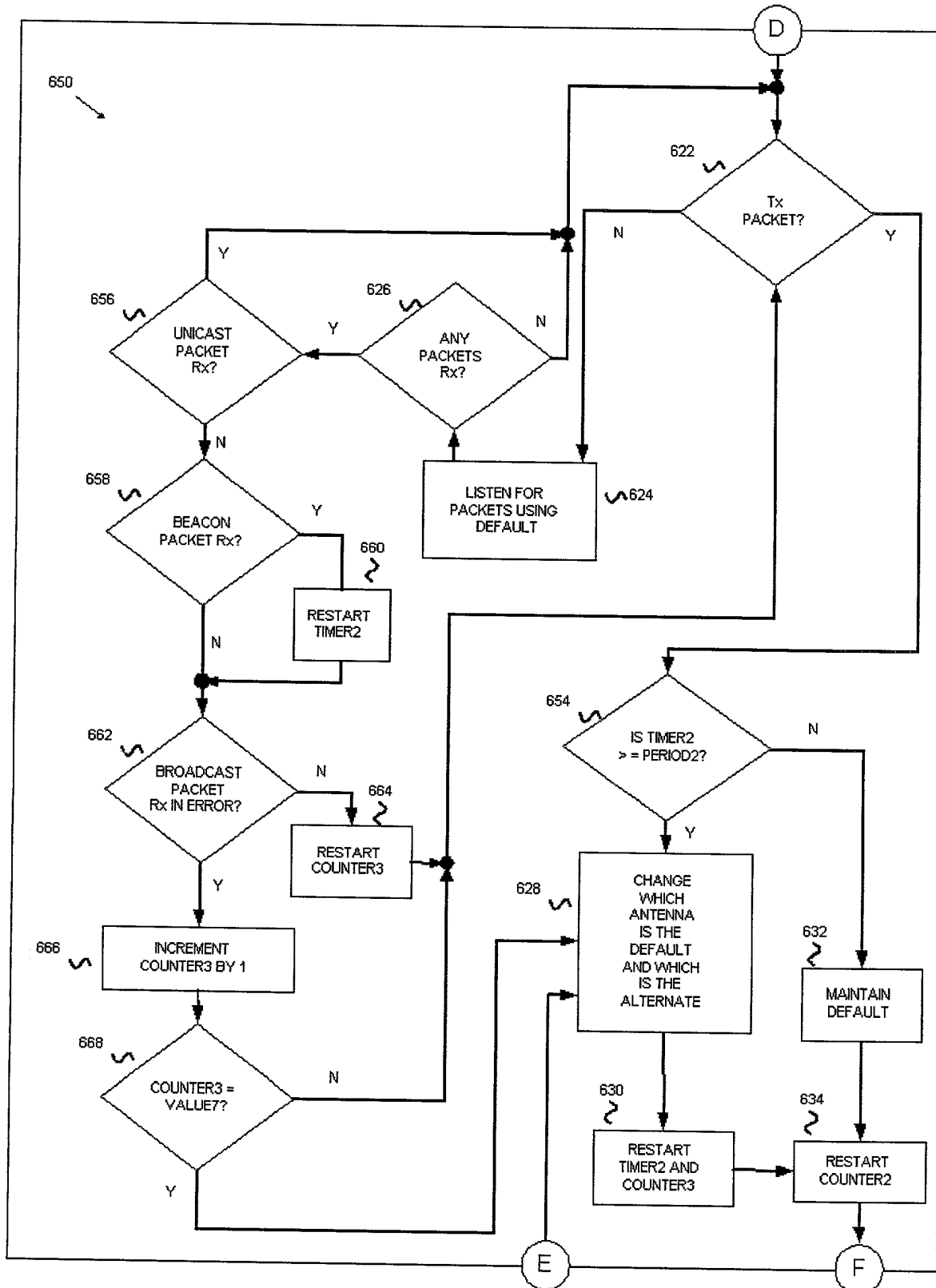

FIG. 7

FIG. 7

"644" 622360

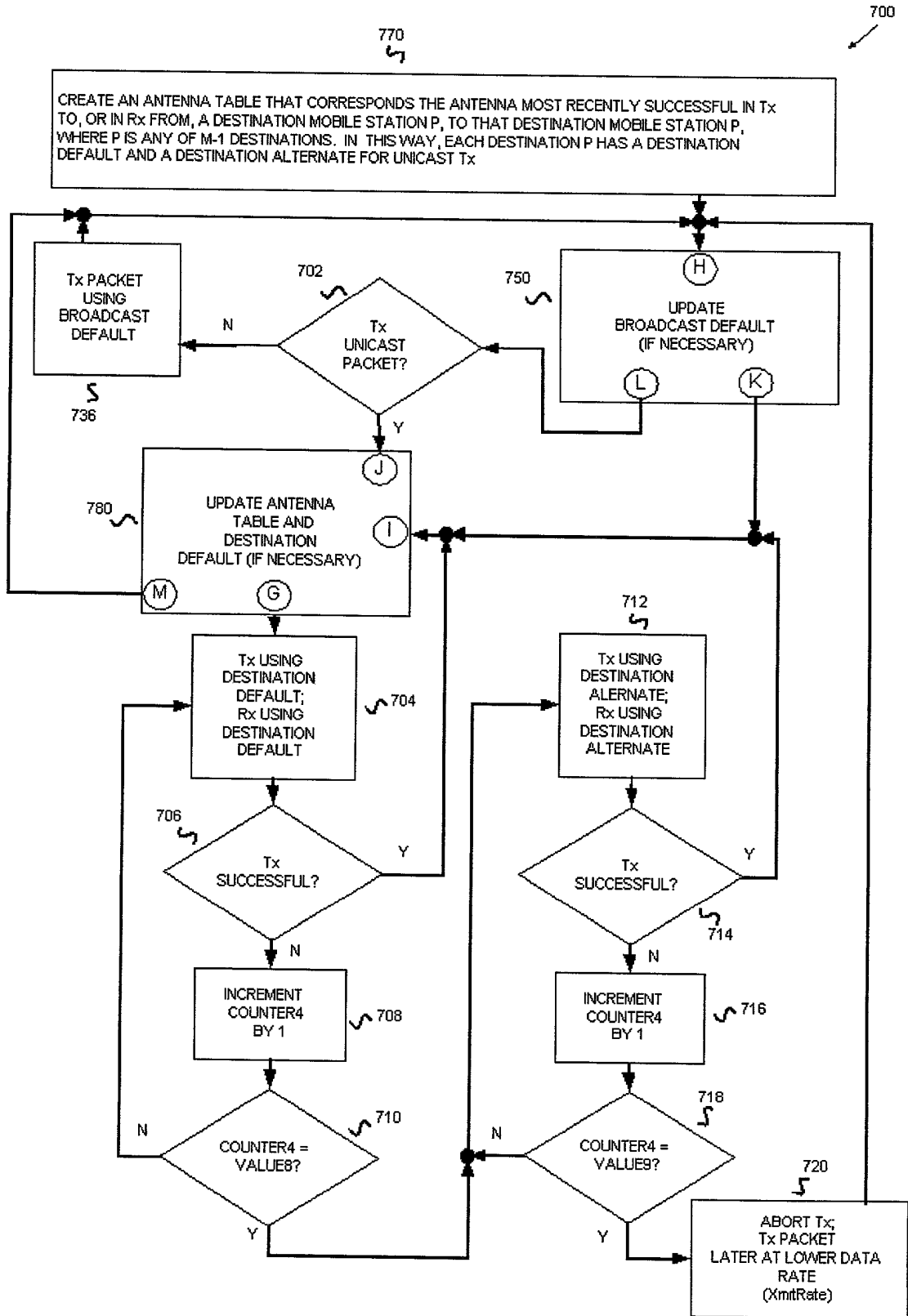

FIG. 8

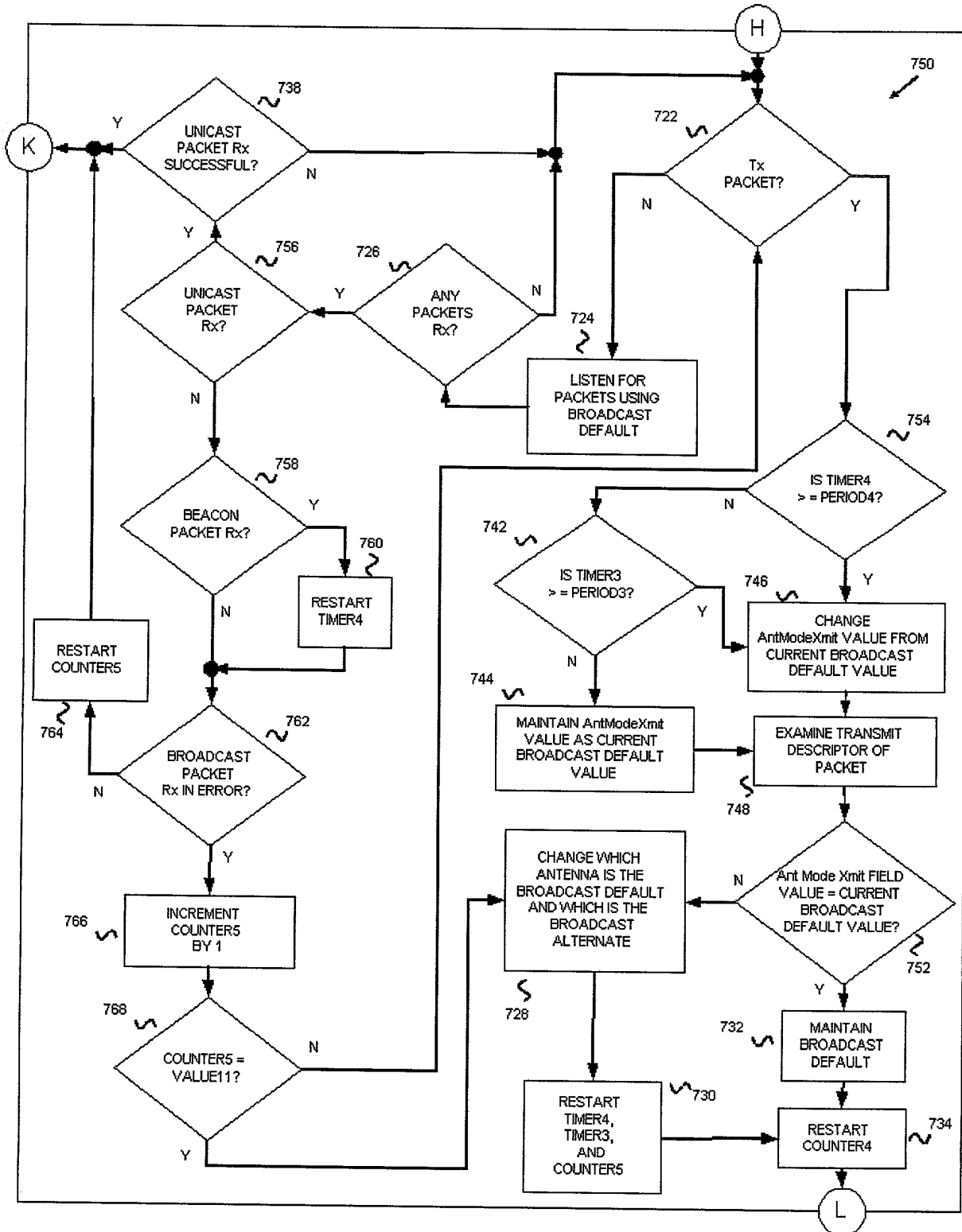

FIG. 9

FIG. 9

FIG. 10

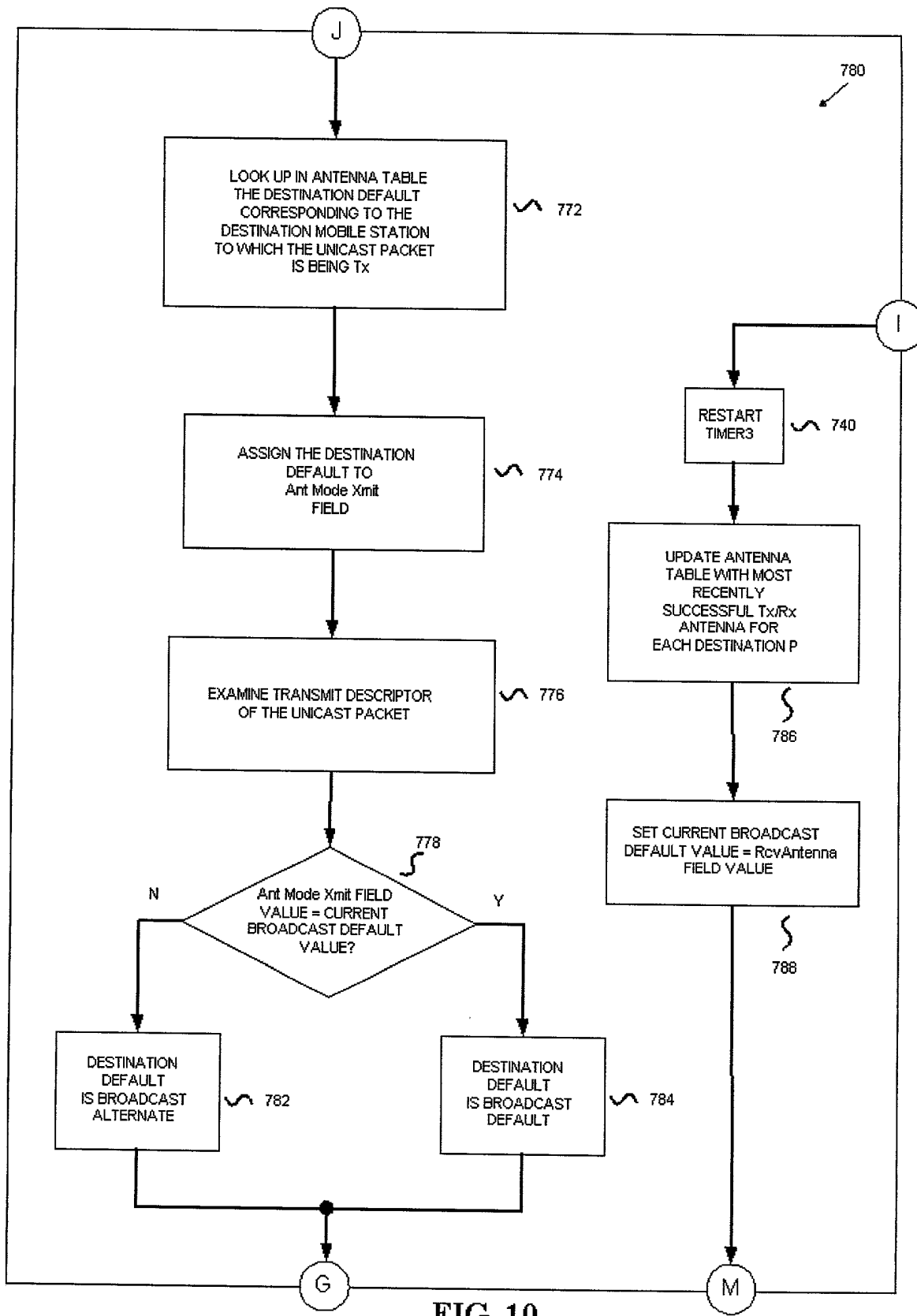

FIG. 10